

SCORPION EXO



SCORPION SPORTS EUROPE

5 rue Gutenberg
67720 Hoerdt, France
www.scorpionsports.eu
info@scorpionsports.eu

Printed in Vietnam

COVER FX

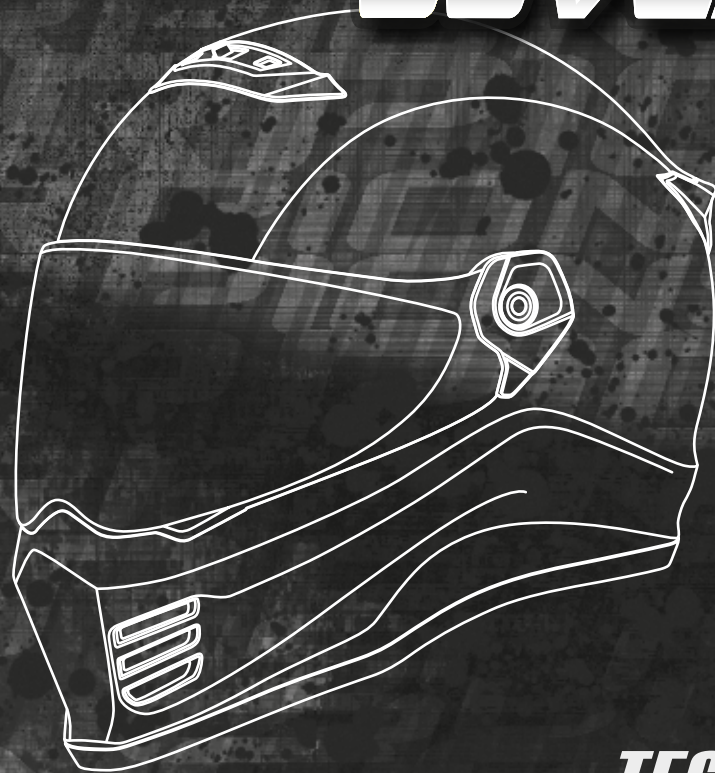

TECH MANUAL

- 1 TCT-U™ Shell**
Developed by Scorpion®, revolutionary new pre-preg technology, TCT-Ultra (TCT-U™) offers unrivaled protection. Extremely light, digressive integrity on impact absorbs more energy.
- 2 KwikWick® III Liner Fabric**
The removable and washable liner features a soft and supple hypo-allergenic, anti-bacterial material with advanced moisture wicking properties.
- 3 Pinlock® Ready FaceShield**
The shield is with Anti-Scratch hardened coating, and is ready for Pinlock® MaxVision® system, the world's best fog free resistant system.
- 4 Speaker Pockets**
Speaker ducts designed into the EPS allow compatibility with communication unit speakers up to 40mm.
- 5 KwikFit®**
Kwikfit® cheekpads allow easy on and off of the most common styles of eye glasses.
- 6 3D Contoured Cheekpads**
Plush removable and washable 3D contoured cheekpads for ultimate fit and comfort lined with our KwikWick® III Fabric.
- 7 Aero-Tuned Ventilation System**
Intake ports across the front of the helmet force cool air into the helmet interior while exhaust vents maximize movement of hot air out of the helmet.

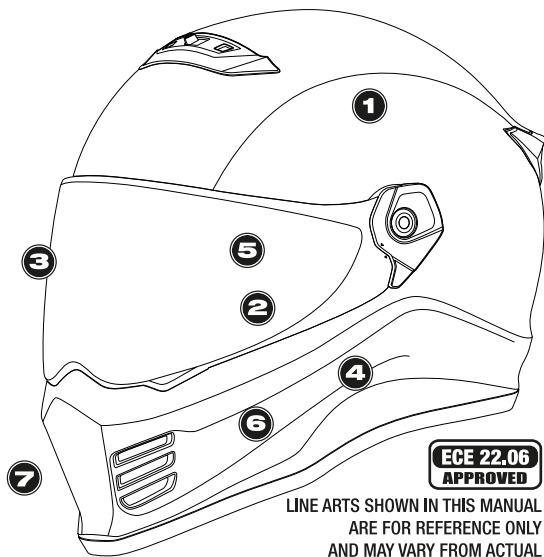

**ECE 22.06
APPROVED**

LINE ARTS SHOWN IN THIS MANUAL
ARE FOR REFERENCE ONLY
AND MAY VARY FROM ACTUAL
PRODUCT.

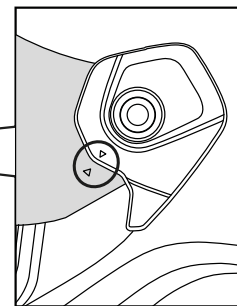
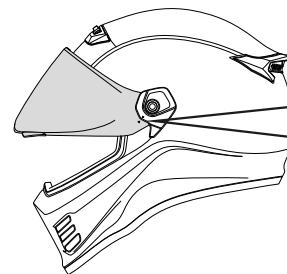
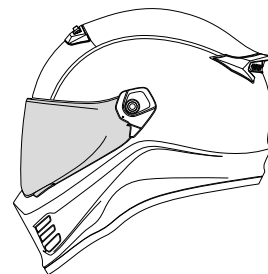

Open the face shield and match arrow each other.

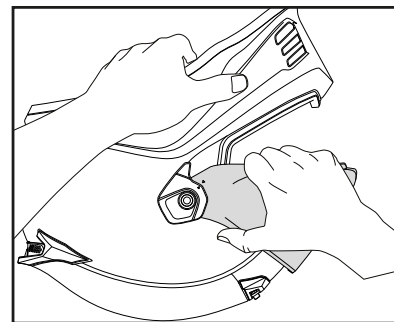

1. Grab the face shield

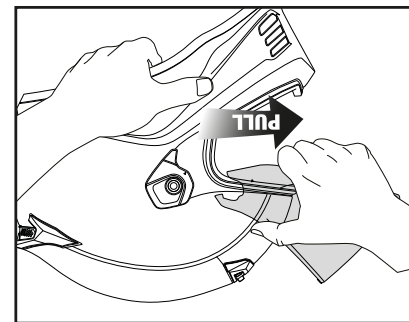

2. Pull off the face shield toward front of the helmet.

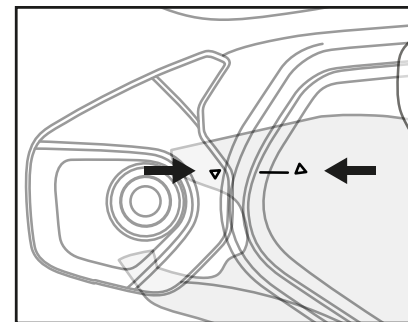

To install the face shield, align the arrow horizontally, and push in the face shield.

CHEEK PADS REMOVAL

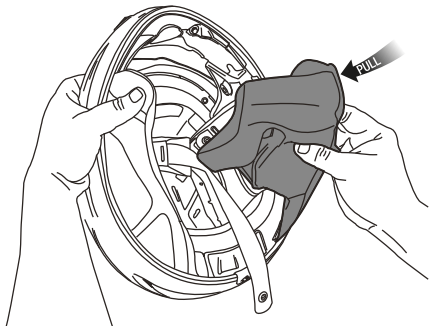

Occasionally the cheek pads may require removal for washing or replacement.

1. Remove the Aero Skirt.
2. Slide your thumb behind the cheek pad at the area closest to the AirFit inflation pump.
3. Gently tug the cheek pad away from the helmet interior wall. There are three plastic snaps that require unsnapping. At the same time slide the plastic trim out of the helmet channel.

Repeat this process for both cheek pads.

Reverse this process for installation.

CROWN LINER REMOVAL

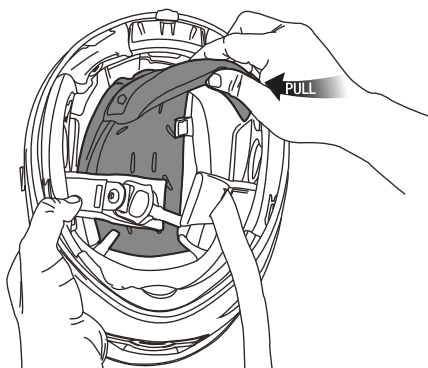

Occasionally the crown liner may require removal for washing, replacement or to change sizes.

1. Remove the cheek pads.
2. At the back of the helmet pull the crown liner away from the shell unsnapping the two snaps.
3. Pull the crown liner out of the helmet while gently detaching it from the forehead channel.

Reverse this process for installation.

MOUTH VENT

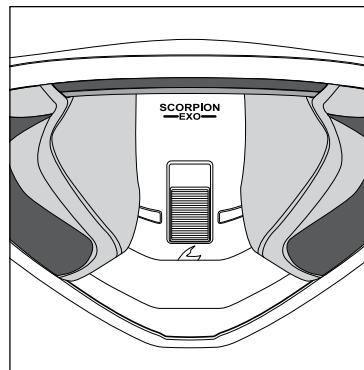

Closed

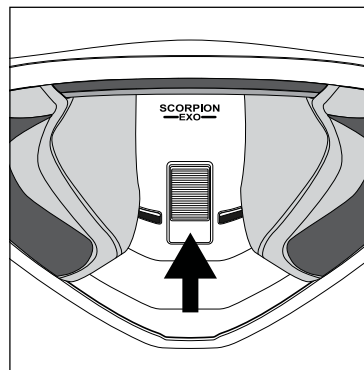

Open

AERO SKIRT REMOVAL

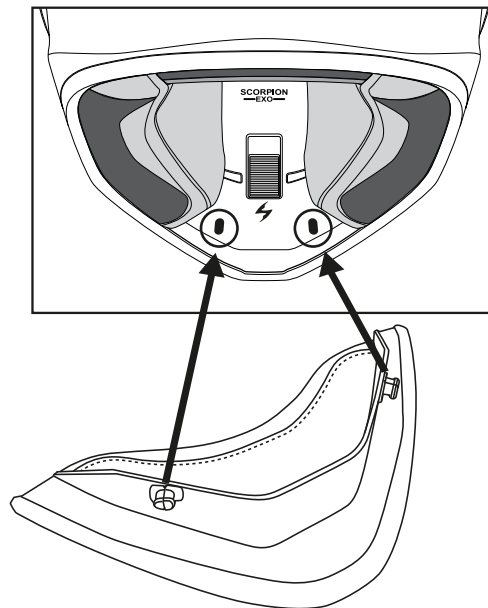

To remove aero skirt from the helmet, grab the aero skirt and unhook two male snaps.

To install aero skirt, reverse the process.

- 1 Coque en TCT-U™**
Scorpion® a développé une toute nouvelle technologie pour une protection sans égale: TCT-Ultra (TCT-U™). Extrêmement légère, cette toute nouvelle structure permet une absorption plus progressive du choc en cas d'impact.
- 2 Revêtement KwikWick® III**
Amovible et lavable, il se compose d'une matière douce et souple, hypoallergénique et antibactérienne pour vous offrir une meilleure absorption de l'humidité et une respirabilité de la peau.
- 3 Pinlock® 100% MaxVision®**
Ecran traité anti-rayures creusé et pré-percé pour intégrer la lentille Pinlock® 100% MaxVision® (traitée anti-buée).
- 4 Emplacement pour Écouteurs**
Un emplacement pour vos écouteurs et système Intercom est disponible au EPS de votre casque.
- 5 KwikFit®**
Les mousses de joue KwikFit® permettent la mise en place et le retrait aisé de lunettes classiques.
- 6 Mousses de Joes Sculptées en 3D**
En trois dimensions sculpté, mousse triple densité que les contours de la forme de la tête du pilote pour un meilleur confort et ajustement.
- 7 Ventilation Venturi Avancée**
Des entrées et évacuation d'air pour une circulation optimale spécialement conçu dans des conditions chaudes et la chaleur dans des conditions fermées.

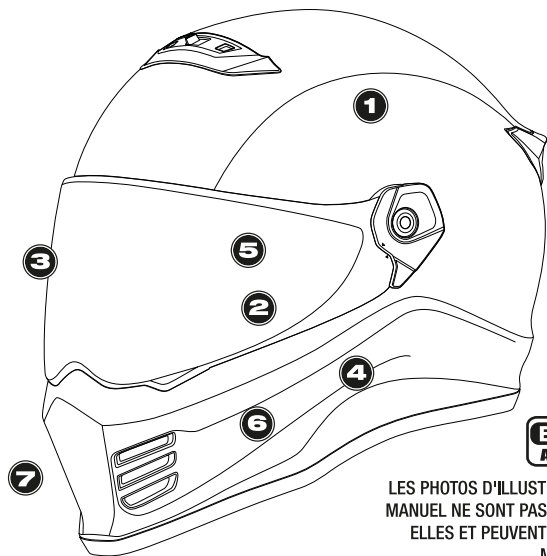

ECE 22.06
APPROVED

LES PHOTOS D'ILLUSTRATION DE CE MANUEL NE SONT PAS CONTRACTUELLES ET PEUVENT DIFFÉRER DU MODÈLE RÉEL.

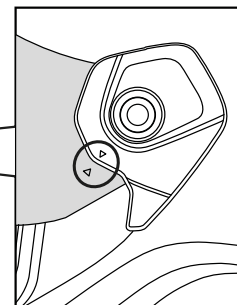
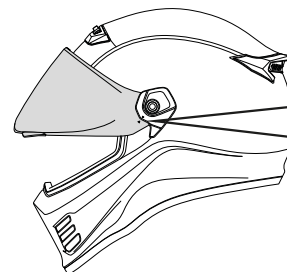
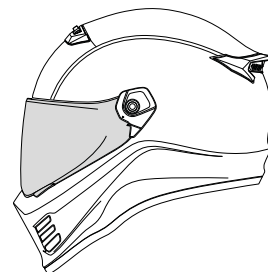

Ouvrez l'écran et alignez les marques triangulaires.

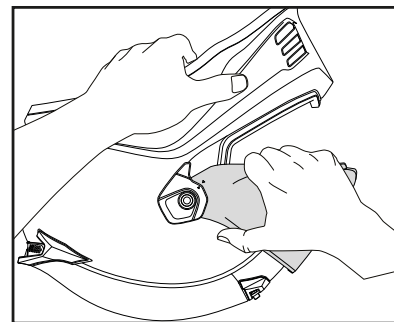

1. Tenir l'écran

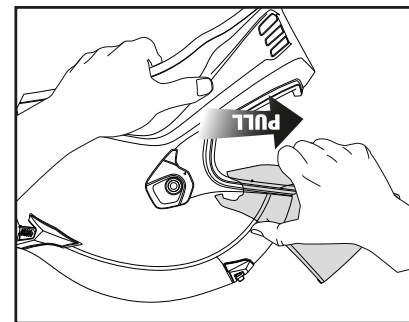

2. Tirer l'écran vers l'avant du casque

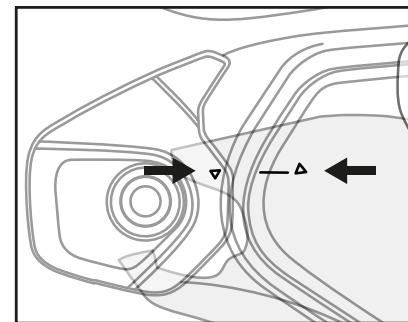

Pour installer l'écran, alignez les repères triangulaires et poussez l'écran dans son logement.

ENLEVER LES MOUSSE DE JOUES

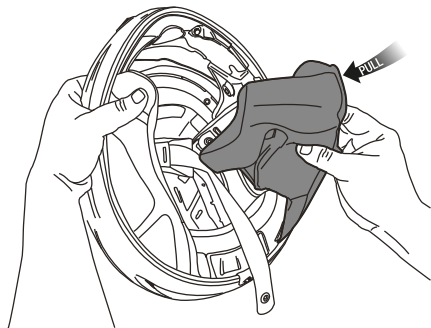

Il arrive d'avoir besoin de démonter le tour de cou ainsi que les mousses de joue (pour les laver par exemple).

Première étape: retirez le cache-menton.

Seconde étape: Glissez vos doigts sous le tour de cou dans la zone proche de la pompe AirFit et retirez doucement le tour de cou de l'intérieur du casque. Il y a trois pressions en plastique qui exigent d'être détachées.

Répéter pour l'autre côté.

ENLEVER LA COIFFE

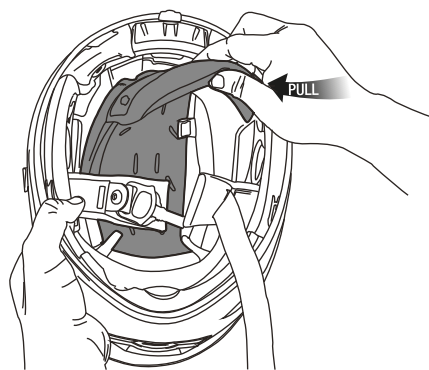

Une fois que les 2 mousses de joues ont été retirées prendre l'arrière de la coiffe et tirer cette partie vers l'avant pour la déboutonner.

Cette partie étant détachée, prendre la coiffe à l'avant et tirer doucement pour que la pièce plastique sorte de son emplacement.

Pour réinstaller la coiffe et les mousses de joues procéder à l'inverse.

VENTILATION MENTON

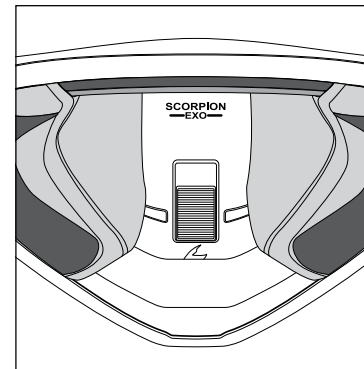

Fermée

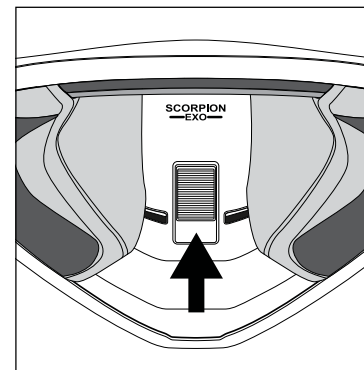

Ouverte

RETRAIT DE LA BAVETTE

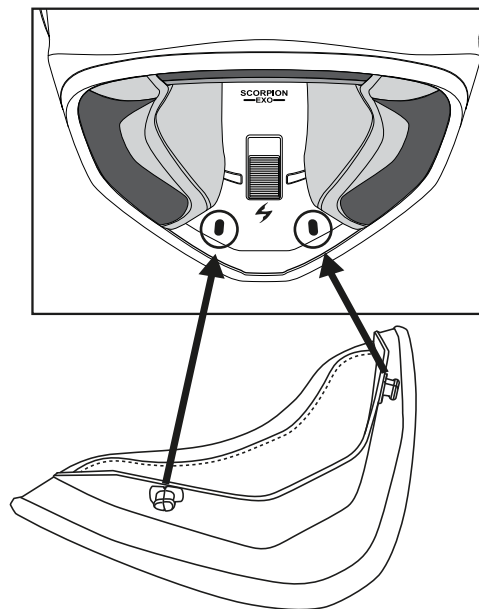

Pour retirer la bavette du casque, attraper la bavette et déclipser les deux boutons-pression mâles. Retirer la bavette de la coque.

Pour installer la bavette, inverser le processus.

- 1 TCT-U™**
Scorpion® hat eine revolutionäre neue Prepreg-Technologie erschaffen, TCT-Ultra (TCT-U™) bietet einen unübertroffenen Schutz. Extrem leicht, die neue Technologie absorbiert beim Aufprall mehr Energie.
- 2 KwikWick® III Innenfutter**
Das herausnehmbare und waschbare Innenfutter besteht aus einem sanften und zarten sowie antiallergenen, antibakteriellen Stoff und absorbiert Feuchtigkeit.
- 3 Pinlock® 100% MaxVision®**
Mit gehärteter kratzfesten Beschichtung und abgesetzter Innenfläche, um Platz für die Pinlock® 100% MaxVision® Linse zu schaffen.
- 4 Lautsprecher Tasche**
EPS weise eine praktische Tasche für Ihren Lautsprecher auf.
- 5 KwikFit®**
Dank KwikFit® Wangenpolster können die meisten geläufigen Brillentypen bequem an- und ausgezogen werden.
- 6 Dreidimensional konturierte Wangenpolster**
Dreidimensional geformter, dreifach-Density-Schaum für besseren Komfort und Passform für den Fahrer.
- 7 Fortgeschrittene Ventui-Ventilation**
Speziell konstruierte Luftkanäle für eine optimale Luftströmung bei warmer Umgebung sowie auch bei kalten Konditionen.

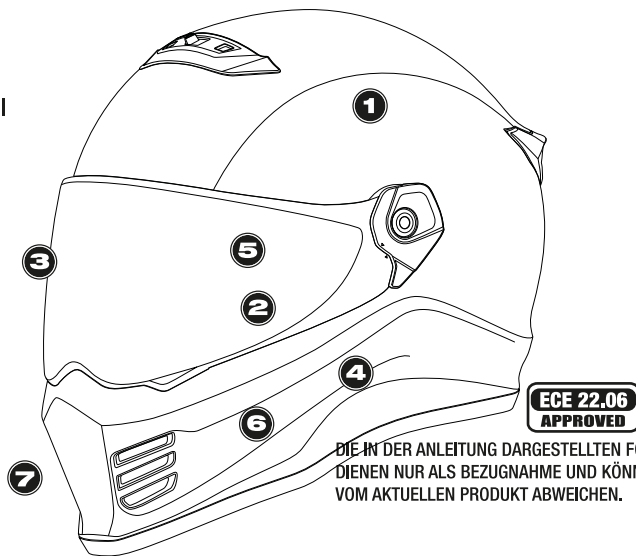

DIE IN DER ANLEITUNG DARGESTELLTEN FOTOS
DIENEN NUR ALS BEZUGNAHME UND KÖNNEN
VOM AKTUELLEN PRODUKT ABWEICHEN.

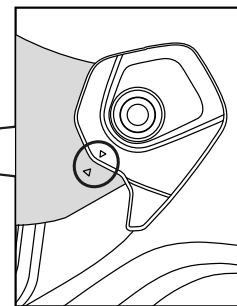
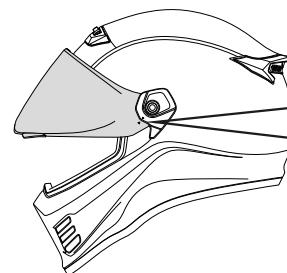
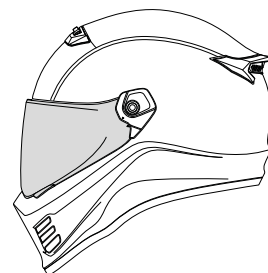

Öffnen Sie das Visier und richten die Dreiecksmarkierungen am Helm und Visier zueinander aus

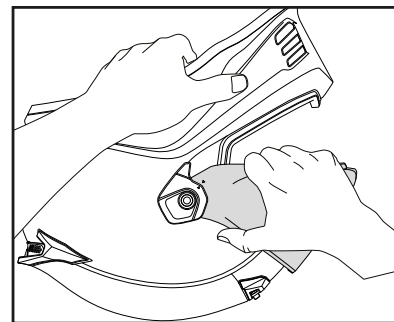

1. Nehmen sie das Visier in die Hand

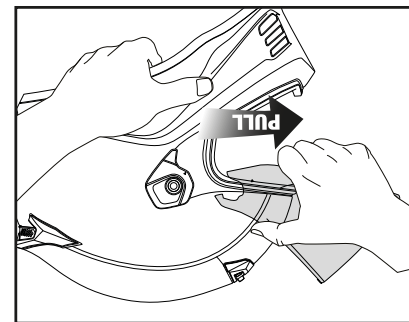

2. Ziehen sie das Visier nach vorne vom Helm ab

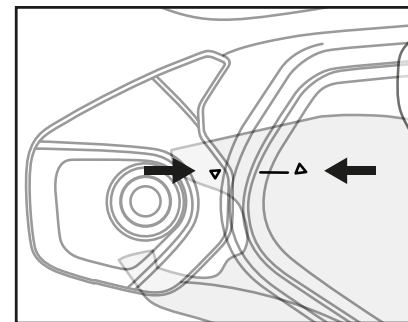

Richten Sie zum Anbringen des Visieres die dreieckigen Markierungen horizontal aus und drücken Sie das Visier in die Führungen hinein.

**ABNEHMEN
DER WANGENPOLSTER**

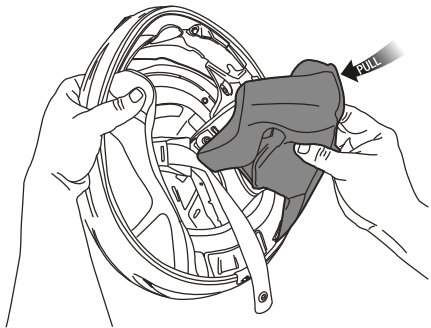

Zunächst muss der Kinn-Windschutz (AeroSkirt) entfernt werden.

Gleiten Sie mit Ihrem Daumen hinter das Wangenpolster, in dem Bereich, der AirFit-Aufblaspumpe am nächsten liegt und ziehen dann das Wangenpolstervorsichtig von der Helminnenseite ab.

Dabei müssen drei Plastikknöpfe abgeknöpft werden. Gleichzeitig ziehen Sie die Plastikverkleidung aus der Helmrinne heraus.

Wiederholen Sie diesen Vorgang für beide Wangenpolster.

**ABNEHMEN
DES HELMFUTTERS**

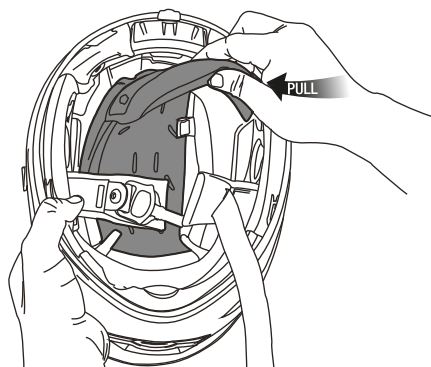

Nachdem die beiden Wangenpolster herausgenommen sind, fassen Sie das Helmfutter in der Nähe des Hinterkopfs und ziehen es in Richtung Augenausschnitt, um es aus den Kunststoffschnappern zu lösen.

Nachdem es aus den Schnappern gelöst ist, ziehen Sie vorsichtig am Helmfutter um es aus der Einspannrille auf Stirnhöhe zu lösen.

Gehen Sie beim Einsetzen des Helmfutters und der Wangenpolster in umgekehrter Reihenfolge vor.

FRONT BELÜFTUNG

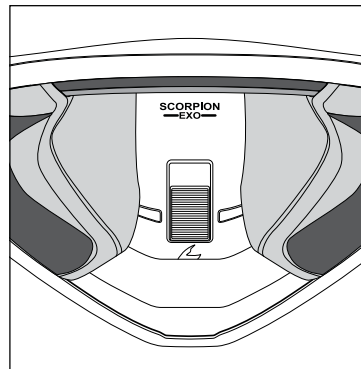

Geschlossen

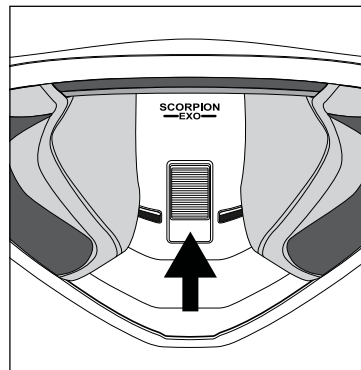

Offen

KINNDEFLEKTOR (WINDABWEISER)

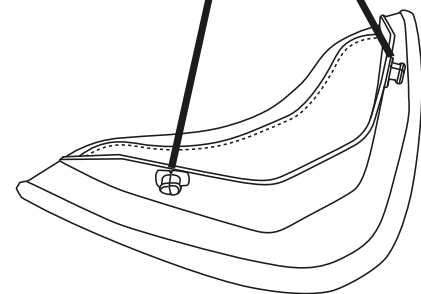
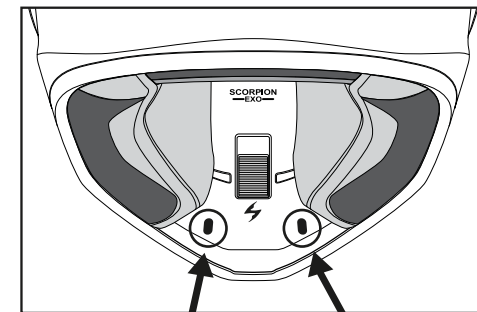

Um den Kinndeflektor vom Helm zu entfernen, greifen Sie ihn von unten und haken die zwei Druckknöpfe aus. Ziehen Sie ihn von der Schale weg.

Um den Kinndeflektor zu installieren, drehen sie den Prozess um.

1 Cáscara de TCT-U™

Extremadamente ligera, intergridad disgresiva que absorbe mas energia, ofrece una protección sin rival. Desarrollada por Scorpion®, nueva tecnología pre-preg revolucionaria, TCT-Ultra (TCT-U™).

2 Forro KwikWick® III

Es posible sacar y lavar, es suave, elástico, higiénico, está hecho con material específico avanzado que puede evitar la humedad.

3 Pinlock® 100% MaxVision®

Pantalla antirrayas con hueco y lente insertada Pinlock® 100% Max Vision® resistente al vaho.

4 Bolsillo de Altavoz

En la EPS se encuentran los bolsillos para los dispositivos de altavoz.

5 KwikFit®

Las espumas laterales KwikFit® permiten ponerse y quitarse fácilmente los estilos más comunes de gafas.

6 Almohadas 3D

Almohadillas interiores tridimensionales contorneadas.

7 Ventilación Venturi Avanzado

Son orificios de entrada y salida de aire diseñados exclusivamente para posibilitar una ventilación óptimo en días de calor, y mantener el calor en días de frío.

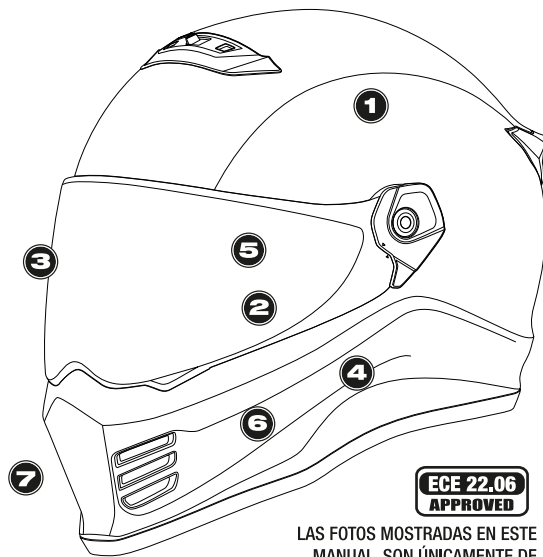

ECE 22.06
APPROVED

LAS FOTOS MOSTRADAS EN ESTE MANUAL, SON ÚNICAMENTE DE REFERENCIA Y PUEDEN VARIAR DEL PRODUCTO REAL.

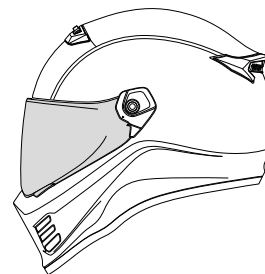

Abra la pantalla externa y junte las marcas triangulares, una con otra.

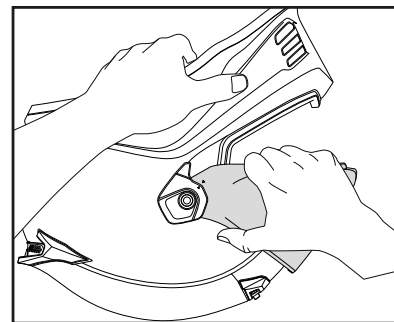
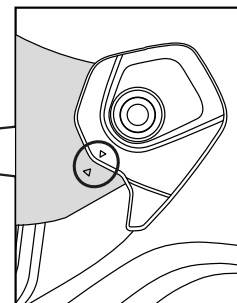
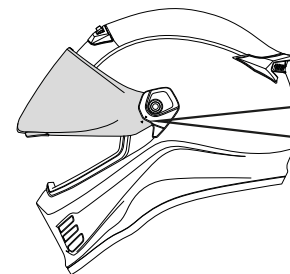

Coge la pantalla.

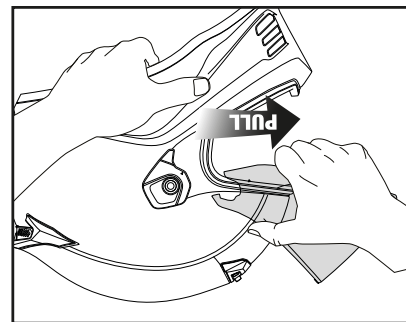

Tira de la pantalla hacia fuera del casco.

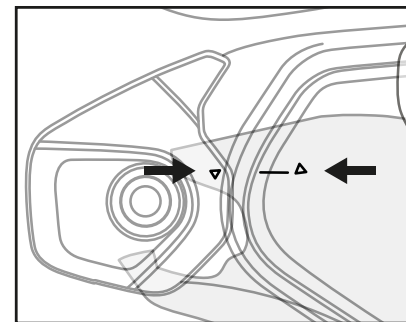

Para poner la pantalla, alinear los triángulos, y poner la pantalla en su alojamiento.

**PARA QUITAR
LAS ESPUMAS LATERALES**

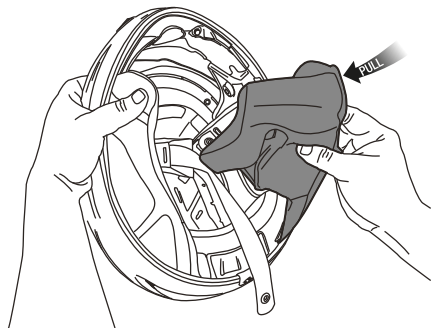

El primer paso es quitar el Aero Skirt.

Luego, con el pulgar por detrás de la espuma lateral en el área más cercana a la bomba de inflado AirFit, tire suavemente de la espuma lateral para separarla de la pared de interior del casco. Se separa la almohadilla apretando los tres botones de plástico.

Al mismo tiempo, hay que empujar el apoyador de plástico del borde del casco.

Repita este proceso para ambas espumas laterales.

**PARA QUITAR
EL ACOLCHADO DE CORONA**

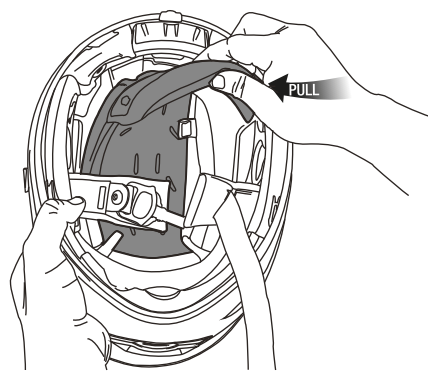

El primer paso es quitar las espumas laterales.

Detrás del casco, separe el acolchado de corona de la carcasa desabrochando los dos botones a presión (mostrados en amarillo).

Saque el acolchado de corona del casco separándolo suavemente del canal de la frente.

Invierta este proceso para la instalación.

VENTILACIÓN MENTÓN

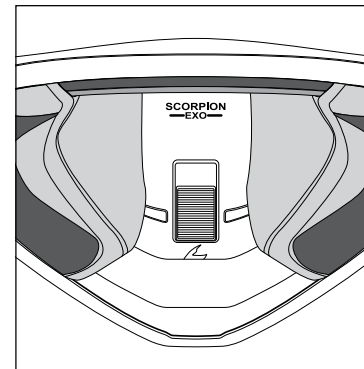

Cerrado

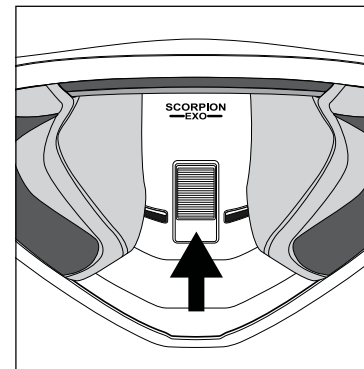

Abierto

BABERO EXTRAIBLE.

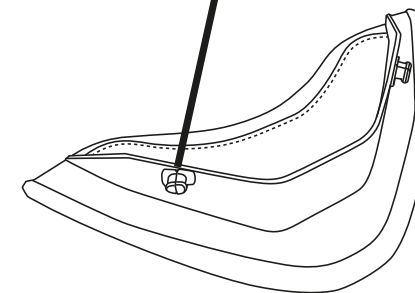
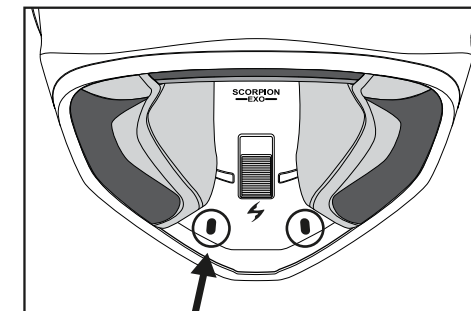

Para extraer el babero del casco, coger el babero y desabrochar los dos botones de presión machos. Retirar el babero.

Para instalar el babero , revertir el proceso.

1 Calotta TCT®

Sviluppato in esclusiva da Scorpion®, il nuovo e rivoluzionario sistema TCT-Ultra (TCT-U™) offre una protezione senza eguali. Estremamente leggera, la calotta, in caso di impatto, consente un maggior assorbimento dell'energia grazie alla sua capacità di deformarsi.

2 Interni KwikWick® III

Interni estraibili e lavabili in materiale ipoallergenico, con trattamento antibatterico ed elastico per garantire una traspirazione ottimale.

3 Pinlock® 100% MaxVision®

Dotata di un rivestimento anti-graffio, ha la superficie interna predisposta per il montaggio della lente Pinlock® 100% MaxVision®.

4 Alloggiamento Altoparlanti

Gli alloggiamenti laterali nell'EPS sono predisposti per posizionare gli altoparlanti dell'interfono.

5 KwikFit®

I guanciali interni Kwikfit® permettono un facile posizionamento e rimozione degli occhiali.

6 Guanciali Sagomati con Tre-dimensioni

Sagomati tridimensionalmente, sono composti da schiuma a tripla densità che si adatta alla forma della testa del pilota per un miglior comfort e vestibilità.

7 Sistema di Ventilazione

I sistemi di ventilazione appositamente progettati per un flusso d'aria ottimale per massimizzare l'aria fresca e accelerare l'uscita dell'aria calda.

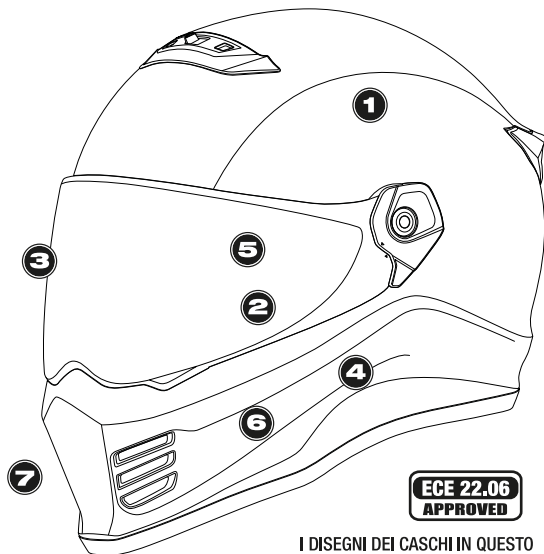

**ECE 22.06
APPROVED**

I DISEGNI DEI CASCHI IN QUESTO MANUALE SERVONO SOLO COME PUNTO DI RIFERIMENTO E POSSONO VARIARE DAI PRODOTTI ATTUALI.

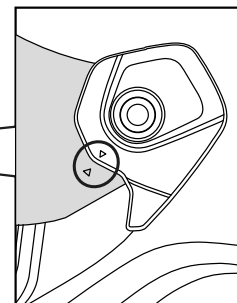
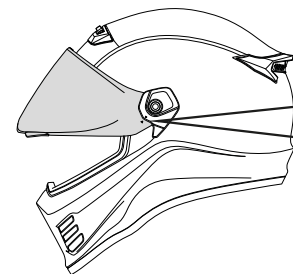
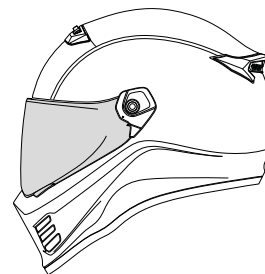

Aprire la visiera e allineare i simboli triangolari

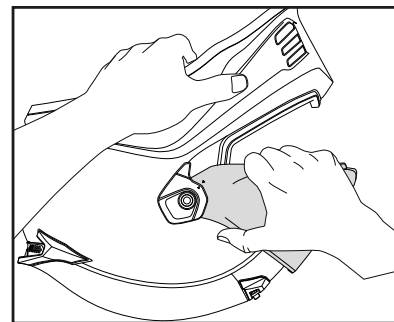

1. Afferrare la visiera

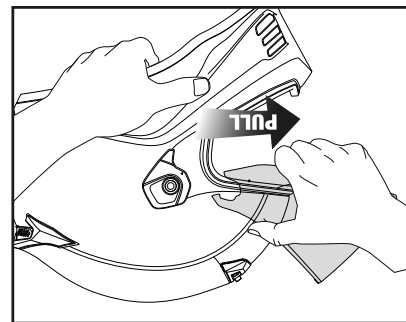

2. Tirare la visiera verso la parte anteriore del casco

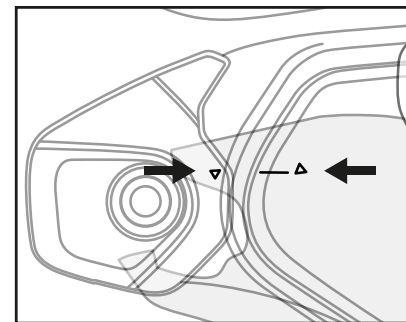

Per installare la visiera, allineare i riferimenti triangolari orizzontalmente e spingere la visiera.

RIMOZIONE DEI GUANCIALI

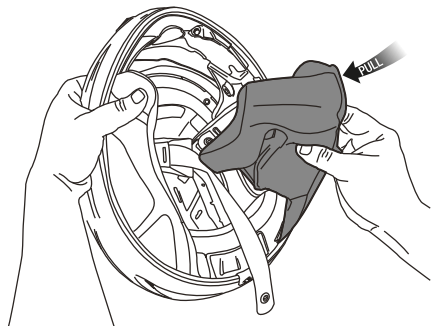

Innanzitutto, bisogna rimuovere l'aero skirt.

Poi, far scorrere il pollice dietro il guanciaie alla zona più vicina alla pompa di gonfiaggio Airfit e tirare delicatamente il guanciaie dalla parete interna del casco, sganciando i tre ganci in plastica.

Si può dunque procedere all'estrazione del guanciaie. Ripetere questa procedura per entrambi i guanciaie.

Per rimontare i guanciaie basta invertire questo procedimento.

RIMOZIONE DELLA CORONA

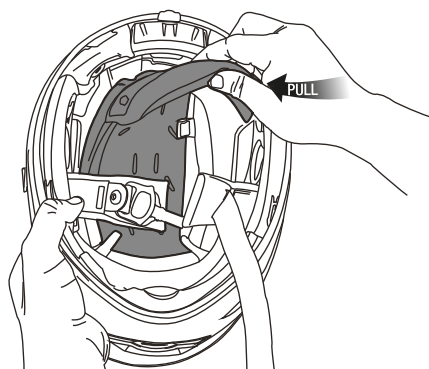

Prima di tutto, rimuovere i guanciaie interni.

Nella parte posteriore del casco, tirare la calottina interna fuori dalla calotta, sganciando i due fermagli.

Staccare delicatamente la corona.

Effettuare il procedimento al contrario per reinserire la corona.

PRESA D'ARIA MENTONIERA

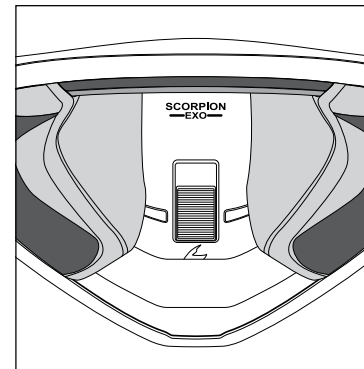

Chiusa

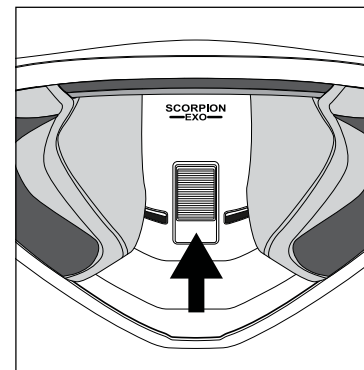

Aperta

RIMOZIONE DEL DEFLETTORE MENTONIERA

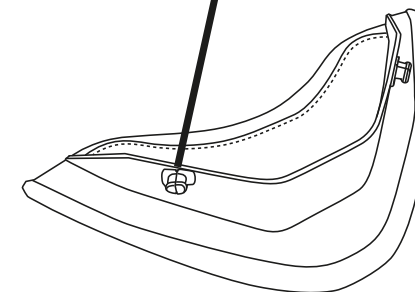
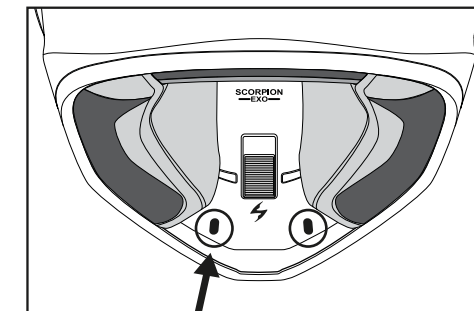

Per rimuovere il deflettore della mentoniera, afferrare il deflettore e sganciare i due bottoni a pressione. Tirare via il deflettore dal casco.

Per installare il deflettore mentoniera invertire il processo

1 Calota em Ultra TCT

Calota em TCT® ou em Composto de Carbono Desenvolvida exclusivamente pela Scorpion, a calota em TCT® (Thermodynamic Composite Technology) é uma mistura de fibras de vidro e fibras orgânicas de poli-resina com o objetivo de criar uma calota leve e durável.

2 Forro em tecido KwikWick III

O forro removível e lavável apresenta um revestimento macio e material flexível hipoalergênico, anti-bacteriano com propriedades avançadas de eliminação da humidade.

3 Viseira Pinlock® 100% MaxVision®

A viseira tem um revestimento endurecido anti-riscos, e está preparado para o sistema Pinlock® MaxVision®, o melhor sistema anti-embaciamento do mundo.

4 Cavidades para Intercomunicador

As cavidades para o intercomunicador desenhadas para o EPS permitem a compatibilidade com intercomunicadores até 50mm.

5 Almofadas Interiores Laterais KwikFit®

As almofadas interiores laterais KwikFit® permitem a colocação da maioria dos óculos.

6 Almofadas laterais em 3D

Almofadas laterais macias removíveis e laváveis em 3D para um ajuste perfeito e confortável, revestidas com o tecido KwikWick III.

7 Sistema de Ventilação Aero-Tuned

As entradas de ar na parte frontal do capacete forçam a entrada de ar fresco para o interior do mesmo fazendo com que o ar quente saia pelas saídas posteriores.

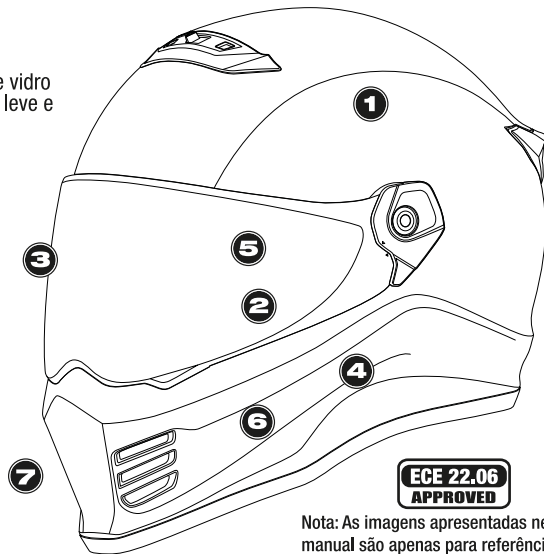

Nota: As imagens apresentadas neste manual são apenas para referência e podem variar do produto real.

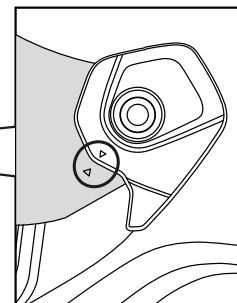
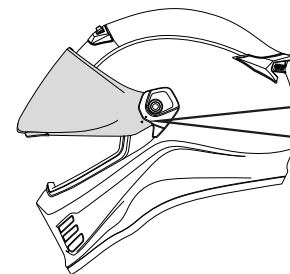
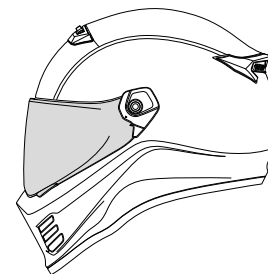

Abra a viseira até fazer coincidir os triângulos.

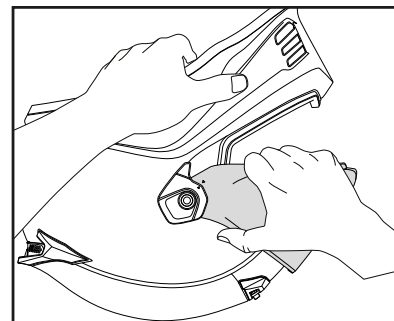

1. Agarre na viseira.

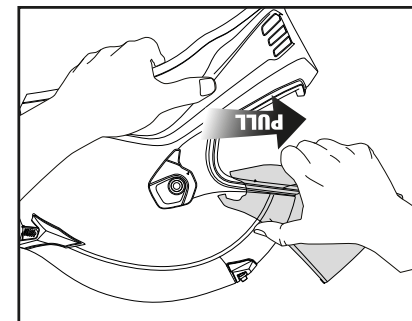

2. Puxe a viseira para a frente do capacete.

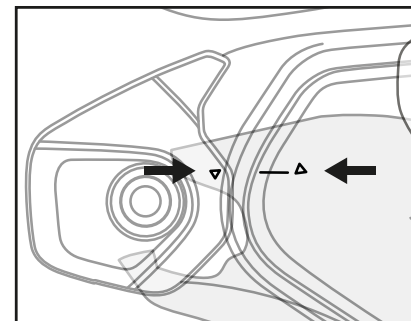

Para instalar a viseira, alinhe os triângulos horizontalmente e empurre a viseira para dentro do mecanismo.

Remoção das almofadas interiores laterais e das da zona do pescoço

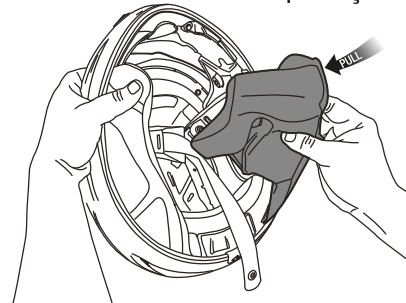

Ocasionalmente, as almofadas interiores laterais e as da zona do pescoço podem necessitar de remoção para lavagem ou substituição.

1. Remova a proteção de queixo.
2. Deslize o polegar entre a almofada da zona do pescoço e almofada lateral na zona mais próxima da bomba de insuflação do sistema Airfit e separe delicadamente a almofada da zona do pescoço/almofada lateral do interior do capacete (Existem três molas de plástico que necessitam de ser abertas longe da área da queixeira).
3. Repita este processo para ambos os lados.

Inverta este processo para instalação.

Uma vez removidas as almofadas interiores laterais e da zona do pescoço, pode remover o forro interior.

Remoção do Forro Interior

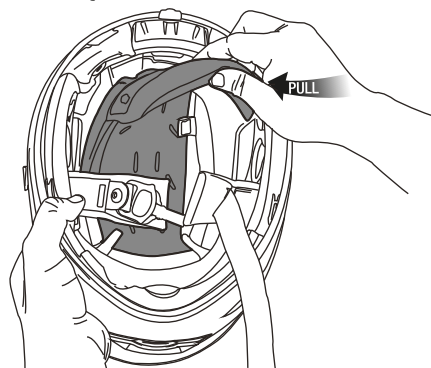

Ocasionalmente, o forro interior pode exigir remoção para lavagem, substituição ou para mudança de tamanho.

1. Remova as almofadas interiores laterais.
2. Na parte de trás do capacete, puxe o forro interior da calota do capacete, abrindo as duas molas.
3. Puxe o forro interior do capacete ao mesmo tempo que desconecta o sistema magnético da zona da testa.

Inverta este processo para instalação.

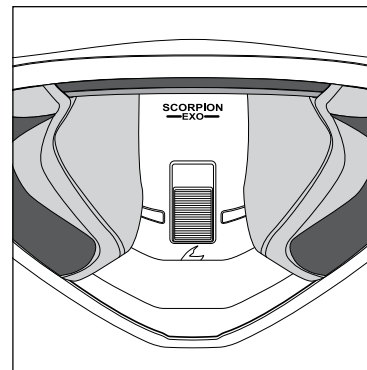

Fechada

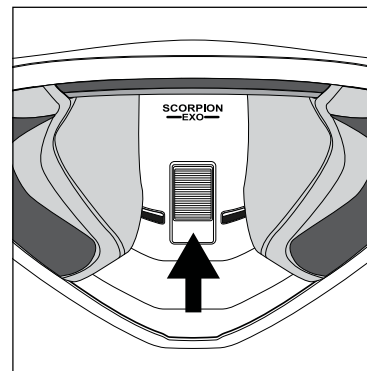

Aberta

REMOÇÃO DA PROTEÇÃO DE QUEIXO

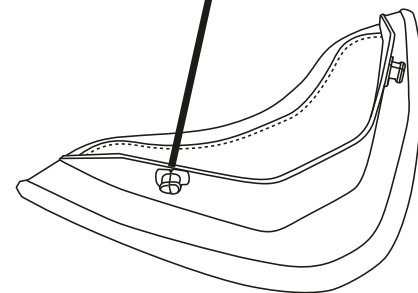
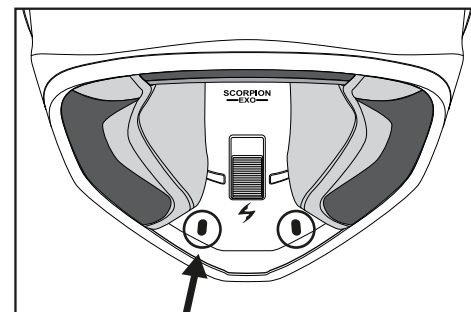

Para remover a proteção do queixo do capacete, segure na mesma e destaque as molas de pressão. Remova a proteção de queixo da calota.

Para voltar a instalar a proteção de queixo, realize o processo inverso.

